

# Compression Fittings

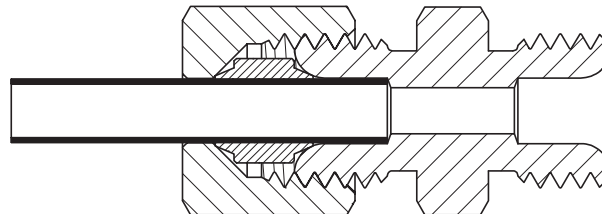

TITON Compression Fittings are designed to comply with established industry standards. This economical fitting is available in a wide range of off-the-shelf sizes and styles. They are manufactured from high quality DZR brass alloy.

### ADVANTAGES

Simple to assemble. No soldering, flaring or deburring is necessary. Suitable for use in a wide variety of applications.

### APPLICATIONS

May be used with copper, aluminium, brass, and plastic tubing. Use with steel tubing is not recommended. Installation should be where low to medium pressures are encountered, and modest tube vibration/movement is involved. Suitable for hazardous liquids, oils, and fuel. **Not recommended for use with gas**

### WORKING PRESSURES

Generally, working pressure is dependant upon the type of tubing used and not the fitting. Consequently the table shown below should be used as a guide only.

### ASSEMBLY

- I. Slide nut then sleeve onto tube ensuring threaded end of nut is facing the sleeve.
- II. If using a plastic tube, push a 261 Insert into tube to prevent tube from collapsing.
- III. Insert the tube into the fitting until the tube has bottomed onto the fitting shoulder.
- IV. Screw nut onto the fitting and tighten "hand tight". **Using the table below, follow the number of additional wrench turns.**

Tube Size	Hydraulic kPa [PSI]	Pneumatic kPa [PSI]	Wrench Turns
1/8	3500 [500]	2000 [290]	1/1
1/3	3500 [500]	1750 [250]	1/1
1/4	2750 [400]	1400 [200]	1/1
1/5	2750 [400]	1400 [200]	1/1
3/8	2000 [290]	1050 [150]	1/1
1/2	2000 [290]	1050 [150]	1½
5/8	1400 [200]	700 [100]	1½
3/4	1400 [200]	700 [100]	1½

C  
O  
M  
P

# Compression Fittings

COMP

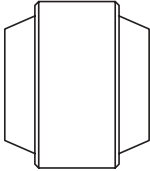
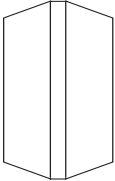
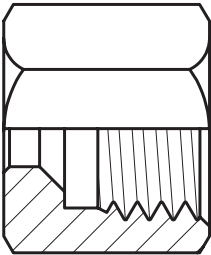
<p><b>60N</b></p> 	<p style="text-align: center;"><b>Sleeve</b> For All Materials. Ideal For Nylon</p> <table border="1"> <thead> <tr> <th>Part Number</th> <th>Standard Pack</th> <th>Tube</th> <th>Pipe Thread</th> </tr> </thead> <tbody> <tr><td>60N02</td><td>100</td><td>1/8</td><td>-</td></tr> <tr><td>60N03</td><td>100</td><td>3/16</td><td>-</td></tr> <tr><td>60N04</td><td>100</td><td>1/4</td><td>-</td></tr> <tr><td>60N05</td><td>100</td><td>5/16</td><td>-</td></tr> <tr><td>60N06</td><td>100</td><td>3/8</td><td>-</td></tr> <tr><td>60N08</td><td>50</td><td>1/2</td><td>-</td></tr> <tr><td>60N10</td><td>50</td><td>5/8</td><td>-</td></tr> <tr><td>60N12</td><td>50</td><td>3/4</td><td>-</td></tr> <tr><td>60N16</td><td>1</td><td>1"</td><td>-</td></tr> </tbody> </table>	Part Number	Standard Pack	Tube	Pipe Thread	60N02	100	1/8	-	60N03	100	3/16	-	60N04	100	1/4	-	60N05	100	5/16	-	60N06	100	3/8	-	60N08	50	1/2	-	60N10	50	5/8	-	60N12	50	3/4	-	60N16	1	1"	-
Part Number	Standard Pack	Tube	Pipe Thread																																						
60N02	100	1/8	-																																						
60N03	100	3/16	-																																						
60N04	100	1/4	-																																						
60N05	100	5/16	-																																						
60N06	100	3/8	-																																						
60N08	50	1/2	-																																						
60N10	50	5/8	-																																						
60N12	50	3/4	-																																						
60N16	1	1"	-																																						
<p><b>60</b></p> 	<p style="text-align: center;"><b>Sleeve</b> Ideal For Copper</p> <table border="1"> <thead> <tr> <th>Part Number</th> <th>Standard Pack</th> <th>Tube</th> <th>Pipe Thread</th> </tr> </thead> <tbody> <tr><td>6002</td><td>100</td><td>1/8</td><td>-</td></tr> <tr><td>6003</td><td>100</td><td>3/16</td><td>-</td></tr> <tr><td>6004</td><td>100</td><td>1/4</td><td>-</td></tr> <tr><td>6005</td><td>100</td><td>5/16</td><td>-</td></tr> <tr><td>6006</td><td>100</td><td>3/8</td><td>-</td></tr> <tr><td>6008</td><td>50</td><td>1/2</td><td>-</td></tr> <tr><td>6010</td><td>50</td><td>5/8</td><td>-</td></tr> <tr><td>6012</td><td>50</td><td>3/4</td><td>-</td></tr> </tbody> </table>	Part Number	Standard Pack	Tube	Pipe Thread	6002	100	1/8	-	6003	100	3/16	-	6004	100	1/4	-	6005	100	5/16	-	6006	100	3/8	-	6008	50	1/2	-	6010	50	5/8	-	6012	50	3/4	-				
Part Number	Standard Pack	Tube	Pipe Thread																																						
6002	100	1/8	-																																						
6003	100	3/16	-																																						
6004	100	1/4	-																																						
6005	100	5/16	-																																						
6006	100	3/8	-																																						
6008	50	1/2	-																																						
6010	50	5/8	-																																						
6012	50	3/4	-																																						
<p><b>61</b></p> 	<p style="text-align: center;"><b>Compression Nut</b></p> <table border="1"> <thead> <tr> <th>Part Number</th> <th>Standard Pack</th> <th>Tube</th> <th>Pipe Thread</th> </tr> </thead> <tbody> <tr><td>6102</td><td>50</td><td>1/8</td><td>-</td></tr> <tr><td>6103</td><td>50</td><td>3/16</td><td>-</td></tr> <tr><td>6104</td><td>50</td><td>1/4</td><td>-</td></tr> <tr><td>6105</td><td>50</td><td>5/16</td><td>-</td></tr> <tr><td>6106</td><td>50</td><td>3/8</td><td>-</td></tr> <tr><td>6108</td><td>25</td><td>1/2</td><td>-</td></tr> <tr><td>6110</td><td>15</td><td>5/8</td><td>-</td></tr> <tr><td>6112</td><td>15</td><td>3/4</td><td>-</td></tr> <tr><td>6116</td><td>1</td><td>1"</td><td>-</td></tr> </tbody> </table>	Part Number	Standard Pack	Tube	Pipe Thread	6102	50	1/8	-	6103	50	3/16	-	6104	50	1/4	-	6105	50	5/16	-	6106	50	3/8	-	6108	25	1/2	-	6110	15	5/8	-	6112	15	3/4	-	6116	1	1"	-
Part Number	Standard Pack	Tube	Pipe Thread																																						
6102	50	1/8	-																																						
6103	50	3/16	-																																						
6104	50	1/4	-																																						
6105	50	5/16	-																																						
6106	50	3/8	-																																						
6108	25	1/2	-																																						
6110	15	5/8	-																																						
6112	15	3/4	-																																						
6116	1	1"	-																																						

# Compression Fittings

**C  
O  
M  
P**

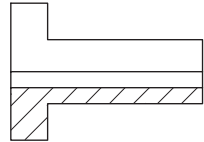
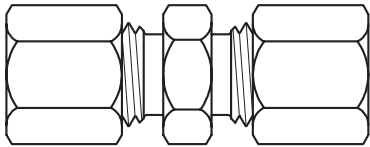
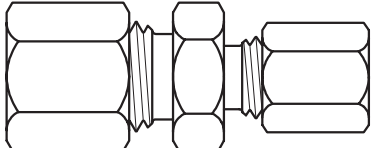
<p style="text-align: center;"><b>Hose Insert</b></p> <p style="text-align: center;">Provides Support For Plastic Tubes</p> <table border="1" style="width: 100%; border-collapse: collapse; margin-top: 10px;"> <thead> <tr style="background-color: #ffffcc;"> <th style="text-align: left;">Part Number</th> <th style="text-align: left;">Standard Pack</th> <th style="text-align: left;">Tube OD</th> <th style="text-align: left;">Tube ID</th> </tr> </thead> <tbody> <tr><td>26103</td><td>50</td><td>3/16</td><td>3.10mm</td></tr> <tr><td>26104</td><td>50</td><td>1/4</td><td>3.86mm</td></tr> <tr><td>26105</td><td>50</td><td>5/16</td><td>5.03mm</td></tr> <tr><td>26106</td><td>20</td><td>3/8</td><td>5.84mm</td></tr> <tr><td>26108</td><td>20</td><td>1/2</td><td>9.14mm</td></tr> <tr><td>26110</td><td>10</td><td>5/8</td><td>12.20mm</td></tr> </tbody> </table>	Part Number	Standard Pack	Tube OD	Tube ID	26103	50	3/16	3.10mm	26104	50	1/4	3.86mm	26105	50	5/16	5.03mm	26106	20	3/8	5.84mm	26108	20	1/2	9.14mm	26110	10	5/8	12.20mm	<p style="font-size: 24pt; font-weight: bold;">261</p> 								
Part Number	Standard Pack	Tube OD	Tube ID																																		
26103	50	3/16	3.10mm																																		
26104	50	1/4	3.86mm																																		
26105	50	5/16	5.03mm																																		
26106	20	3/8	5.84mm																																		
26108	20	1/2	9.14mm																																		
26110	10	5/8	12.20mm																																		
<p style="text-align: center;"><b>Double Union</b></p> <p style="text-align: center;">Supplied Complete With 60N Sleeves and 61 Nuts</p> <table border="1" style="width: 100%; border-collapse: collapse; margin-top: 10px;"> <thead> <tr style="background-color: #ffffcc;"> <th style="text-align: left;">Part Number</th> <th style="text-align: left;">Standard Pack</th> <th style="text-align: left;">Tube</th> <th style="text-align: left;">Pipe Thread</th> </tr> </thead> <tbody> <tr><td>6202</td><td>25</td><td>1/8</td><td>-</td></tr> <tr><td>6203</td><td>25</td><td>3/16</td><td>-</td></tr> <tr><td>6204</td><td>25</td><td>1/4</td><td>-</td></tr> <tr><td>6205</td><td>25</td><td>5/16</td><td>-</td></tr> <tr><td>6206</td><td>25</td><td>3/8</td><td>-</td></tr> <tr><td>6208</td><td>10</td><td>1/2</td><td>-</td></tr> <tr><td>6210</td><td>10</td><td>5/8</td><td>-</td></tr> <tr><td>6212</td><td>5</td><td>3/4</td><td>-</td></tr> </tbody> </table>	Part Number	Standard Pack	Tube	Pipe Thread	6202	25	1/8	-	6203	25	3/16	-	6204	25	1/4	-	6205	25	5/16	-	6206	25	3/8	-	6208	10	1/2	-	6210	10	5/8	-	6212	5	3/4	-	<p style="font-size: 24pt; font-weight: bold;">62</p> 
Part Number	Standard Pack	Tube	Pipe Thread																																		
6202	25	1/8	-																																		
6203	25	3/16	-																																		
6204	25	1/4	-																																		
6205	25	5/16	-																																		
6206	25	3/8	-																																		
6208	10	1/2	-																																		
6210	10	5/8	-																																		
6212	5	3/4	-																																		
<p style="text-align: center;"><b>Reducing Union</b></p> <p style="text-align: center;">Supplied Complete With 60N Sleeves and 61 Nuts</p> <table border="1" style="width: 100%; border-collapse: collapse; margin-top: 10px;"> <thead> <tr style="background-color: #ffffcc;"> <th style="text-align: left;">Part Number</th> <th style="text-align: left;">Standard Pack</th> <th style="text-align: left;">Tube</th> <th style="text-align: left;">Tube</th> </tr> </thead> <tbody> <tr><td>62R0403</td><td>20</td><td>1/4</td><td>42430</td></tr> <tr><td>62R0504</td><td>20</td><td>5/16</td><td>38808</td></tr> <tr><td>62R0604</td><td>20</td><td>3/8</td><td>38808</td></tr> <tr><td>62R0605</td><td>20</td><td>3/8</td><td>42491</td></tr> <tr><td>62R0804</td><td>-</td><td>1/2</td><td>38808</td></tr> <tr><td>62R0806</td><td>5</td><td>1/2</td><td>38932</td></tr> <tr><td>62R1006</td><td>-</td><td>5/8</td><td>38932</td></tr> </tbody> </table>	Part Number	Standard Pack	Tube	Tube	62R0403	20	1/4	42430	62R0504	20	5/16	38808	62R0604	20	3/8	38808	62R0605	20	3/8	42491	62R0804	-	1/2	38808	62R0806	5	1/2	38932	62R1006	-	5/8	38932	<p style="font-size: 24pt; font-weight: bold;">62R</p> 				
Part Number	Standard Pack	Tube	Tube																																		
62R0403	20	1/4	42430																																		
62R0504	20	5/16	38808																																		
62R0604	20	3/8	38808																																		
62R0605	20	3/8	42491																																		
62R0804	-	1/2	38808																																		
62R0806	5	1/2	38932																																		
62R1006	-	5/8	38932																																		

# Compression Fittings

**COMP**

**64**

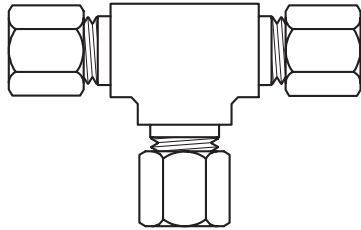

## Union Tee

Supplied Complete With 60N Sleeves and 61 Nuts.

Part Number	Standard Pack	Tube	Pipe Thread
6402	20	1/8	-
6403	10	3/16	-
6404	10	1/4	-
6405	10	5/16	-
6406	10	3/8	-
6408	10	1/2	-
6410	5	5/8	-
6412	-	3/4	-

**65**

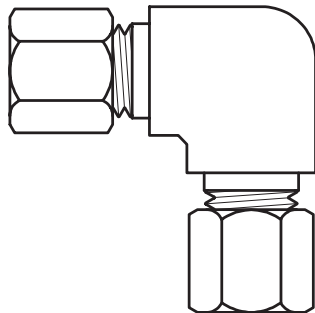

## Union Elbow

Supplied Complete With 60N Sleeves and 61 Nuts.

Part Number	Standard Pack	Tube	Pipe Thread
6502	20	1/8	-
6503	20	3/16	-
6504	20	1/4	-
6505	20	5/16	-
6506	10	3/8	-
6508	10	1/2	-
6510	-	5/8	-
6512	-	3/4	-

**66**

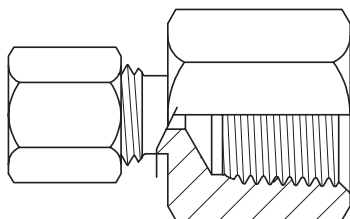

## Female Connector

Supplied Complete With 60N Sleeves and 61 Nuts.

Part Number	Standard Pack	Tube	Pipe Thread
660202	20	1/8	1/8 BSPP
660302	20	3/16	1/8 BSPP
660402	20	1/4	1/8 BSPP
660404	20	1/4	1/4 BSPP
660406	20	1/4	3/8 BSPP
660408	10	1/4	1/2 BSPP
660502	20	5/16	1/8 BSPP
660504	20	5/16	1/4 BSPP
660506	20	5/16	3/8 BSPP

Continued on next page...

# Compression Fittings

...Continued from previous page.

## Female Connector

Part Number	Standard Pack	Tube	Pipe Thread
660602	20	3/8	1/8 BSPP
660604	20	3/8	1/4 BSPP
660606	20	3/8	3/8 BSPP
660608	20	3/8	1/2 BSPP
660806	10	1/2	3/8 BSPP
660808	10	1/2	1/2 BSPP
661208	-	3/4	1/2 BSPP
661212	-	3/4	3/4 BSPP

66

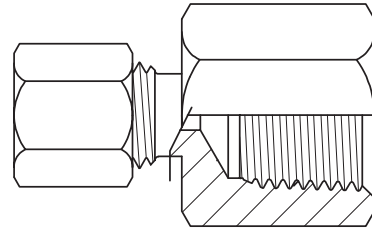

C  
O  
M  
P

## Male Connector

Supplied Complete With 60N Sleeves and 61 Nuts

Part Number	Standard Pack	Tube	Pipe Thread
680202	20	1/8	1/8 BSPT
680204	20	1/8	1/4 BSPT
680302	20	3/16	1/8 BSPT
680304	20	3/16	1/4 BSPT
680402	25	1/4	1/8 BSPT
680404	25	1/4	1/4 BSPT
680406	20	1/4	3/8 BSPT
680408	10	1/4	1/2 BSPT
680412	10	1/4	3/4 BSPT
680502	25	5/16	1/8 BSPT
680504	25	5/16	1/4 BSPT
680506	20	5/16	3/8 BSPT
680508	10	5/16	1/2 BSPT
680602	20	3/8	1/8 BSPT
680604	25	3/8	1/4 BSPT
680606	10	3/8	3/8 BSPT
680608	20	3/8	1/2 BSPT
680804	10	1/2	1/4 BSPT
680806	20	1/2	3/8 BSPT
680808	10	1/2	1/2 BSPT
680812	10	1/2	3/4 BSPT
681006	10	5/8	3/8 BSPT
681008	10	5/8	1/2 BSPT
681012	10	5/8	3/4 BSPT
681204	-	3/4	1/4 BSPT
681208	5	3/4	1/2 BSPT
681212	5	3/4	3/4 BSPT
681616	2	1"	1" BSPT

68

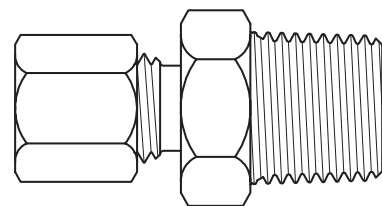

# Compression Fittings

**C  
O  
M  
P**

**69**

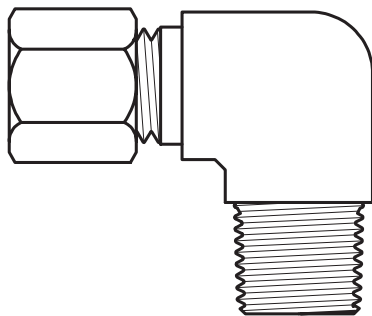

## Male Elbow

Supplied Complete With 60N Sleeves and 61 Nuts.

Part Number	Standard Pack	Tube	Pipe Thread
690202	20	1/8	1/8 BSPT
690302	20	3/16	1/8 BSPT
690402	20	1/4	1/8 BSPT
690404	20	1/4	1/4 BSPT
690406	20	1/4	3/8 BSPT
690502	20	5/16	1/8 BSPT
690504	20	5/16	1/4 BSPT
690602	20	3/8	1/8 BSPT
690604	20	3/8	1/4 BSPT
690606	10	3/8	3/8 BSPT
690608	10	3/8	1/2 BSPT
690804	10	1/2	1/4 BSPT
690806	10	1/2	3/8 BSPT
690808	10	1/2	1/2 BSPT
691006	5	5/8	3/8 BSPT
691008	5	5/8	1/2 BSPT
691208	5	3/4	1/2 BSPT
691212	1	3/4	3/4 BSPT

**70**

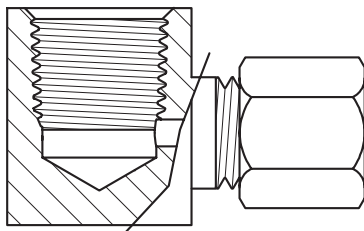

## Female Elbow

Supplied Complete With 60N Sleeves and 61 Nuts.

Part Number	Standard Pack	Tube	Pipe Thread
700202	20	1/8	1/8 BSPP
700302	20	3/16	1/8 BSPP
700402	20	1/4	1/8 BSPP
700604	10	3/8	1/4 BSPP
700806	10	1/2	3/8 BSPP

# Compression Fittings

**COMP**

<p style="text-align: center;"><b>Union Male Run Tee</b></p> <p style="text-align: center;">Supplied Complete With 60N Sleeves and 61 Nuts.</p> <table border="1" style="width: 100%; border-collapse: collapse; margin-top: 10px;"> <thead> <tr style="background-color: #ffffcc;"> <th style="text-align: left;">Part Number</th> <th style="text-align: center;">Standard Pack</th> <th style="text-align: center;">Tube</th> <th style="text-align: center;">Pipe Thread</th> </tr> </thead> <tbody> <tr><td>710202</td><td style="text-align: center;">10</td><td style="text-align: center;">1/8</td><td style="text-align: center;">1/8 BSPT</td></tr> <tr><td>710302</td><td style="text-align: center;">10</td><td style="text-align: center;">3/16</td><td style="text-align: center;">1/8 BSPT</td></tr> <tr><td>710402</td><td style="text-align: center;">10</td><td style="text-align: center;">1/4</td><td style="text-align: center;">1/8 BSPT</td></tr> <tr><td>710404</td><td style="text-align: center;">10</td><td style="text-align: center;">1/4</td><td style="text-align: center;">1/4 BSPT</td></tr> <tr><td>710502</td><td style="text-align: center;">10</td><td style="text-align: center;">5/16</td><td style="text-align: center;">1/8 BSPT</td></tr> <tr><td>710504</td><td style="text-align: center;">10</td><td style="text-align: center;">5/16</td><td style="text-align: center;">1/4 BSPT</td></tr> <tr><td>710604</td><td style="text-align: center;">10</td><td style="text-align: center;">3/8</td><td style="text-align: center;">1/4 BSPT</td></tr> <tr><td>710806</td><td style="text-align: center;">5</td><td style="text-align: center;">1/2</td><td style="text-align: center;">3/8 BSPT</td></tr> </tbody> </table>	Part Number	Standard Pack	Tube	Pipe Thread	710202	10	1/8	1/8 BSPT	710302	10	3/16	1/8 BSPT	710402	10	1/4	1/8 BSPT	710404	10	1/4	1/4 BSPT	710502	10	5/16	1/8 BSPT	710504	10	5/16	1/4 BSPT	710604	10	3/8	1/4 BSPT	710806	5	1/2	3/8 BSPT	<p style="font-size: 2em; font-weight: bold;">71</p>								
Part Number	Standard Pack	Tube	Pipe Thread																																										
710202	10	1/8	1/8 BSPT																																										
710302	10	3/16	1/8 BSPT																																										
710402	10	1/4	1/8 BSPT																																										
710404	10	1/4	1/4 BSPT																																										
710502	10	5/16	1/8 BSPT																																										
710504	10	5/16	1/4 BSPT																																										
710604	10	3/8	1/4 BSPT																																										
710806	5	1/2	3/8 BSPT																																										
<p style="text-align: center;"><b>Union Male Branch Tee</b></p> <p style="text-align: center;">Supplied Complete With 60N Sleeves and 61 Nuts</p> <table border="1" style="width: 100%; border-collapse: collapse; margin-top: 10px;"> <thead> <tr style="background-color: #ffffcc;"> <th style="text-align: left;">Part Number</th> <th style="text-align: center;">Standard Pack</th> <th style="text-align: center;">Tube</th> <th style="text-align: center;">Pipe Thread</th> </tr> </thead> <tbody> <tr><td>720202</td><td style="text-align: center;">20</td><td style="text-align: center;">1/8</td><td style="text-align: center;">1/8 BSPT</td></tr> <tr><td>720302</td><td style="text-align: center;">20</td><td style="text-align: center;">3/16</td><td style="text-align: center;">1/8 BSPT</td></tr> <tr><td>720402</td><td style="text-align: center;">10</td><td style="text-align: center;">1/4</td><td style="text-align: center;">1/8 BSPT</td></tr> <tr><td>720404</td><td style="text-align: center;">10</td><td style="text-align: center;">1/4</td><td style="text-align: center;">1/4 BSPT</td></tr> <tr><td>720502</td><td style="text-align: center;">10</td><td style="text-align: center;">5/16</td><td style="text-align: center;">1/8 BSPT</td></tr> <tr><td>720504</td><td style="text-align: center;">10</td><td style="text-align: center;">5/16</td><td style="text-align: center;">1/4 BSPT</td></tr> <tr><td>720604</td><td style="text-align: center;">10</td><td style="text-align: center;">3/8</td><td style="text-align: center;">1/4 BSPT</td></tr> <tr><td>720606</td><td style="text-align: center;">1</td><td style="text-align: center;">3/8</td><td style="text-align: center;">3/8 BSPT</td></tr> <tr><td>720804</td><td style="text-align: center;">1</td><td style="text-align: center;">1/2</td><td style="text-align: center;">1/4 BSPT</td></tr> <tr><td>720806</td><td style="text-align: center;">1</td><td style="text-align: center;">1/2</td><td style="text-align: center;">3/8 BSPT</td></tr> </tbody> </table>	Part Number	Standard Pack	Tube	Pipe Thread	720202	20	1/8	1/8 BSPT	720302	20	3/16	1/8 BSPT	720402	10	1/4	1/8 BSPT	720404	10	1/4	1/4 BSPT	720502	10	5/16	1/8 BSPT	720504	10	5/16	1/4 BSPT	720604	10	3/8	1/4 BSPT	720606	1	3/8	3/8 BSPT	720804	1	1/2	1/4 BSPT	720806	1	1/2	3/8 BSPT	<p style="font-size: 2em; font-weight: bold;">72</p>
Part Number	Standard Pack	Tube	Pipe Thread																																										
720202	20	1/8	1/8 BSPT																																										
720302	20	3/16	1/8 BSPT																																										
720402	10	1/4	1/8 BSPT																																										
720404	10	1/4	1/4 BSPT																																										
720502	10	5/16	1/8 BSPT																																										
720504	10	5/16	1/4 BSPT																																										
720604	10	3/8	1/4 BSPT																																										
720606	1	3/8	3/8 BSPT																																										
720804	1	1/2	1/4 BSPT																																										
720806	1	1/2	3/8 BSPT																																										
<p style="text-align: center;"><b>Male/Female Run Tee</b></p> <p style="text-align: center;">Supplied Complete With 60N Sleeves and 61 Nuts</p> <table border="1" style="width: 100%; border-collapse: collapse; margin-top: 10px;"> <thead> <tr style="background-color: #ffffcc;"> <th style="text-align: left;">Part Number</th> <th style="text-align: center;">Standard Pack</th> <th style="text-align: center;">Tube</th> <th style="text-align: center;">Pipe Thread</th> </tr> </thead> <tbody> <tr><td>760202</td><td style="text-align: center;">10</td><td style="text-align: center;">1/8</td><td style="text-align: center;">1/8 BSPT</td></tr> <tr><td>760302</td><td style="text-align: center;">10</td><td style="text-align: center;">3/16</td><td style="text-align: center;">1/8 BSPT</td></tr> <tr><td>760402</td><td style="text-align: center;">10</td><td style="text-align: center;">1/4</td><td style="text-align: center;">1/8 BSPT</td></tr> <tr><td>760502</td><td style="text-align: center;">10</td><td style="text-align: center;">5/16</td><td style="text-align: center;">1/8 BSPT</td></tr> <tr><td>760604</td><td style="text-align: center;">10</td><td style="text-align: center;">3/8</td><td style="text-align: center;">1/4 BSPT</td></tr> </tbody> </table>	Part Number	Standard Pack	Tube	Pipe Thread	760202	10	1/8	1/8 BSPT	760302	10	3/16	1/8 BSPT	760402	10	1/4	1/8 BSPT	760502	10	5/16	1/8 BSPT	760604	10	3/8	1/4 BSPT	<p style="font-size: 2em; font-weight: bold;">76</p>																				
Part Number	Standard Pack	Tube	Pipe Thread																																										
760202	10	1/8	1/8 BSPT																																										
760302	10	3/16	1/8 BSPT																																										
760402	10	1/4	1/8 BSPT																																										
760502	10	5/16	1/8 BSPT																																										
760604	10	3/8	1/4 BSPT																																										

# Metric Compression Fittings

COMP

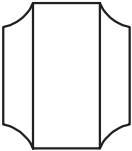
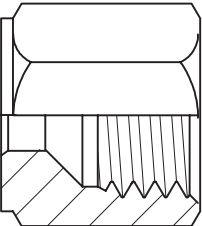
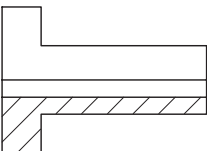
<p><b>M60N</b></p> 	<p style="text-align: center;"><b>Metric Sleeve</b> For All Materials. Ideal For Nylon</p> <table border="1"> <thead> <tr> <th>Part Number</th> <th>Standard Pack</th> <th>Tube</th> <th>Pipe Thread</th> </tr> </thead> <tbody> <tr><td>M60N04</td><td>50</td><td>4 mm</td><td>-</td></tr> <tr><td>M60N06</td><td>50</td><td>6 mm</td><td>-</td></tr> <tr><td>M60N08</td><td>50</td><td>8 mm</td><td>-</td></tr> <tr><td>M60N10</td><td>50</td><td>10 mm</td><td>-</td></tr> <tr><td>M60N12</td><td>20</td><td>12 mm</td><td>-</td></tr> <tr><td>M60N16</td><td>20</td><td>16 mm</td><td>-</td></tr> </tbody> </table>	Part Number	Standard Pack	Tube	Pipe Thread	M60N04	50	4 mm	-	M60N06	50	6 mm	-	M60N08	50	8 mm	-	M60N10	50	10 mm	-	M60N12	20	12 mm	-	M60N16	20	16 mm	-
Part Number	Standard Pack	Tube	Pipe Thread																										
M60N04	50	4 mm	-																										
M60N06	50	6 mm	-																										
M60N08	50	8 mm	-																										
M60N10	50	10 mm	-																										
M60N12	20	12 mm	-																										
M60N16	20	16 mm	-																										
<p><b>M61</b></p> 	<p style="text-align: center;"><b>Metric Compression Nut</b></p> <table border="1"> <thead> <tr> <th>Part Number</th> <th>Standard Pack</th> <th>Tube</th> <th>Pipe Thread</th> </tr> </thead> <tbody> <tr><td>M6104</td><td>20</td><td>4 mm</td><td>-</td></tr> <tr><td>M6106</td><td>20</td><td>6 mm</td><td>-</td></tr> <tr><td>M6108</td><td>20</td><td>8 mm</td><td>-</td></tr> <tr><td>M6110</td><td>20</td><td>10 mm</td><td>-</td></tr> <tr><td>M6112</td><td>20</td><td>12 mm</td><td>-</td></tr> <tr><td>M6116</td><td>10</td><td>16 mm</td><td>-</td></tr> </tbody> </table>	Part Number	Standard Pack	Tube	Pipe Thread	M6104	20	4 mm	-	M6106	20	6 mm	-	M6108	20	8 mm	-	M6110	20	10 mm	-	M6112	20	12 mm	-	M6116	10	16 mm	-
Part Number	Standard Pack	Tube	Pipe Thread																										
M6104	20	4 mm	-																										
M6106	20	6 mm	-																										
M6108	20	8 mm	-																										
M6110	20	10 mm	-																										
M6112	20	12 mm	-																										
M6116	10	16 mm	-																										
<p><b>M261</b></p> 	<p style="text-align: center;"><b>Metric Hose Insert</b> Provides Support For Plastic Tubes.</p> <table border="1"> <thead> <tr> <th>Part Number</th> <th>Standard Pack</th> <th>Tube OD</th> <th>Tube ID</th> </tr> </thead> <tbody> <tr><td>M26104</td><td>50</td><td>4 mm</td><td>2.25 mm</td></tr> <tr><td>M26106</td><td>50</td><td>6 mm</td><td>3.50 mm</td></tr> <tr><td>M26108</td><td>50</td><td>8 mm</td><td>5.05 mm</td></tr> <tr><td>M26110</td><td>50</td><td>10 mm</td><td>6.35 mm</td></tr> <tr><td>M26112</td><td>50</td><td>12 mm</td><td>8.40 mm</td></tr> </tbody> </table>	Part Number	Standard Pack	Tube OD	Tube ID	M26104	50	4 mm	2.25 mm	M26106	50	6 mm	3.50 mm	M26108	50	8 mm	5.05 mm	M26110	50	10 mm	6.35 mm	M26112	50	12 mm	8.40 mm				
Part Number	Standard Pack	Tube OD	Tube ID																										
M26104	50	4 mm	2.25 mm																										
M26106	50	6 mm	3.50 mm																										
M26108	50	8 mm	5.05 mm																										
M26110	50	10 mm	6.35 mm																										
M26112	50	12 mm	8.40 mm																										



# Metric Compression Fittings

**C  
O  
M  
P**

<p style="text-align: center;"><b>Metric Double Union</b></p> <p style="text-align: center;">Supplied Complete With M60N Sleeves and M61 Nuts</p> <table border="1" style="width: 100%; border-collapse: collapse; margin-top: 10px;"> <thead> <tr style="background-color: #ffffcc;"> <th style="text-align: left;">Part Number</th> <th style="text-align: center;">Standard Pack</th> <th style="text-align: left;">Tube</th> <th style="text-align: left;">Pipe Thread</th> </tr> </thead> <tbody> <tr><td>M6204</td><td style="text-align: center;">10</td><td>4 mm</td><td>-</td></tr> <tr><td>M6206</td><td style="text-align: center;">10</td><td>6 mm</td><td>-</td></tr> <tr><td>M6208</td><td style="text-align: center;">10</td><td>8 mm</td><td>-</td></tr> <tr><td>M6210</td><td style="text-align: center;">10</td><td>10 mm</td><td>-</td></tr> <tr><td>M6212</td><td style="text-align: center;">5</td><td>12 mm</td><td>-</td></tr> <tr><td>M6216</td><td style="text-align: center;">5</td><td>16 mm</td><td>-</td></tr> </tbody> </table>	Part Number	Standard Pack	Tube	Pipe Thread	M6204	10	4 mm	-	M6206	10	6 mm	-	M6208	10	8 mm	-	M6210	10	10 mm	-	M6212	5	12 mm	-	M6216	5	16 mm	-	<h2 style="margin: 0;">M62</h2>
Part Number	Standard Pack	Tube	Pipe Thread																										
M6204	10	4 mm	-																										
M6206	10	6 mm	-																										
M6208	10	8 mm	-																										
M6210	10	10 mm	-																										
M6212	5	12 mm	-																										
M6216	5	16 mm	-																										
<p style="text-align: center;"><b>Metric Union Tee</b></p> <p style="text-align: center;">Supplied Complete With M60N Sleeves and M61 Nuts</p> <table border="1" style="width: 100%; border-collapse: collapse; margin-top: 10px;"> <thead> <tr style="background-color: #ffffcc;"> <th style="text-align: left;">Part Number</th> <th style="text-align: center;">Standard Pack</th> <th style="text-align: left;">Tube</th> <th style="text-align: left;">Pipe Thread</th> </tr> </thead> <tbody> <tr><td>M6404</td><td style="text-align: center;">1</td><td>4 mm</td><td>-</td></tr> <tr><td>M6406</td><td style="text-align: center;">1</td><td>6 mm</td><td>-</td></tr> <tr><td>M6408</td><td style="text-align: center;">1</td><td>8 mm</td><td>-</td></tr> <tr><td>M6410</td><td style="text-align: center;">1</td><td>10 mm</td><td>-</td></tr> <tr><td>M6412</td><td style="text-align: center;">1</td><td>12 mm</td><td>-</td></tr> <tr><td>M6416</td><td style="text-align: center;">1</td><td>16 mm</td><td>-</td></tr> </tbody> </table>	Part Number	Standard Pack	Tube	Pipe Thread	M6404	1	4 mm	-	M6406	1	6 mm	-	M6408	1	8 mm	-	M6410	1	10 mm	-	M6412	1	12 mm	-	M6416	1	16 mm	-	<h2 style="margin: 0;">M64</h2>
Part Number	Standard Pack	Tube	Pipe Thread																										
M6404	1	4 mm	-																										
M6406	1	6 mm	-																										
M6408	1	8 mm	-																										
M6410	1	10 mm	-																										
M6412	1	12 mm	-																										
M6416	1	16 mm	-																										
<p style="text-align: center;"><b>Metric Union Elbow</b></p> <p style="text-align: center;">Supplied Complete With M60N Sleeves and M61 Nuts</p> <table border="1" style="width: 100%; border-collapse: collapse; margin-top: 10px;"> <thead> <tr style="background-color: #ffffcc;"> <th style="text-align: left;">Part Number</th> <th style="text-align: center;">Standard Pack</th> <th style="text-align: left;">Tube</th> <th style="text-align: left;">Pipe Thread</th> </tr> </thead> <tbody> <tr><td>M6504</td><td style="text-align: center;">1</td><td>4 mm</td><td>-</td></tr> <tr><td>M6506</td><td style="text-align: center;">1</td><td>6 mm</td><td>-</td></tr> <tr><td>M6508</td><td style="text-align: center;">1</td><td>8 mm</td><td>-</td></tr> <tr><td>M6510</td><td style="text-align: center;">1</td><td>10 mm</td><td>-</td></tr> <tr><td>M6512</td><td style="text-align: center;">1</td><td>12 mm</td><td>-</td></tr> <tr><td>M6516</td><td style="text-align: center;">1</td><td>16 mm</td><td>-</td></tr> </tbody> </table>	Part Number	Standard Pack	Tube	Pipe Thread	M6504	1	4 mm	-	M6506	1	6 mm	-	M6508	1	8 mm	-	M6510	1	10 mm	-	M6512	1	12 mm	-	M6516	1	16 mm	-	<h2 style="margin: 0;">M65</h2>
Part Number	Standard Pack	Tube	Pipe Thread																										
M6504	1	4 mm	-																										
M6506	1	6 mm	-																										
M6508	1	8 mm	-																										
M6510	1	10 mm	-																										
M6512	1	12 mm	-																										
M6516	1	16 mm	-																										
<p style="text-align: center;"><b>Metric Female Connector</b></p> <p style="text-align: center;">Supplied Complete With M60N Sleeves and M61 Nuts</p> <table border="1" style="width: 100%; border-collapse: collapse; margin-top: 10px;"> <thead> <tr style="background-color: #ffffcc;"> <th style="text-align: left;">Part Number</th> <th style="text-align: center;">Standard Pack</th> <th style="text-align: left;">Tube</th> <th style="text-align: left;">Pipe Thread</th> </tr> </thead> <tbody> <tr><td>M660604</td><td style="text-align: center;">1</td><td>6 mm</td><td>1/4 BSPP</td></tr> <tr><td>M660804</td><td style="text-align: center;">1</td><td>8 mm</td><td>1/4 BSPP</td></tr> <tr><td>M661004</td><td style="text-align: center;">1</td><td>10 mm</td><td>1/4 BSPP</td></tr> <tr><td>M661006</td><td style="text-align: center;">1</td><td>10 mm</td><td>3/8 BSPP</td></tr> <tr><td>M661208</td><td style="text-align: center;">1</td><td>12 mm</td><td>1/2 BSPP</td></tr> </tbody> </table>	Part Number	Standard Pack	Tube	Pipe Thread	M660604	1	6 mm	1/4 BSPP	M660804	1	8 mm	1/4 BSPP	M661004	1	10 mm	1/4 BSPP	M661006	1	10 mm	3/8 BSPP	M661208	1	12 mm	1/2 BSPP	<h2 style="margin: 0;">M66</h2>				
Part Number	Standard Pack	Tube	Pipe Thread																										
M660604	1	6 mm	1/4 BSPP																										
M660804	1	8 mm	1/4 BSPP																										
M661004	1	10 mm	1/4 BSPP																										
M661006	1	10 mm	3/8 BSPP																										
M661208	1	12 mm	1/2 BSPP																										

# Metric Compression Fittings

**COMP**

## M68

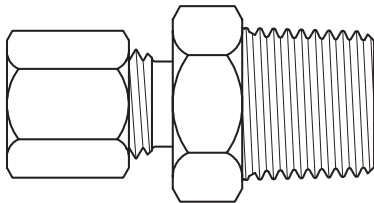

### Metric Male Connector

Supplied Complete With M60N Sleeves and M61 Nuts.

Part Number	Standard Pack	Tube	Pipe Thread
M680402	10	4 mm	1/8 BSPT
M680404	10	4 mm	1/4 BSPT
M680602	10	6 mm	1/8 BSPT
M680604	10	6 mm	1/4 BSPT
M680606	10	6 mm	3/8 BSPT
M680802	10	8 mm	1/8 BSPT
M680804	10	8 mm	1/4 BSPT
M680806	10	8 mm	3/8 BSPT
M680808	10	8 mm	1/2 BSPT
M681002	10	10 mm	1/8 BSPT
M681004	10	10 mm	1/4 BSPT
M681006	10	10 mm	3/8 BSPT
M681008	10	10 mm	1/2 BSPT
M681204	10	12 mm	1/4 BSPT
M681206	10	12 mm	3/8 BSPT
M681208	10	12 mm	1/2 BSPT
M681606	5	16 mm	3/9 BSPT
M681608	5	16 mm	1/2 BSPT

## M69

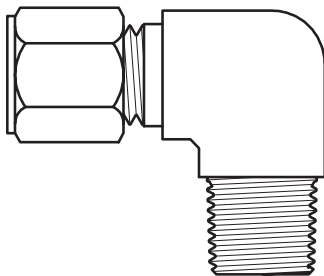

### Metric Male Elbow

Supplied Complete With M60N Sleeves and M61 Nuts.

Part Number	Standard Pack	Tube	Pipe Thread
M690402	10	4 mm	1/8 BSPT
M690404	10	4 mm	1/4 BSPT
M690602	10	6 mm	1/8 BSPT
M690604	10	6 mm	1/4 BSPT
M690606	10	6 mm	3/8 BSPT
M690802	10	8 mm	1/8 BSPT
M690804	10	8 mm	1/4 BSPT
M690806	10	8 mm	3/8 BSPT
M691002	10	10 mm	1/8 BSPT
M691004	10	10 mm	1/4 BSPT
M691006	10	10 mm	3/8 BSPT
M691204	5	12 mm	1/4 BSPT
M691206	5	12 mm	3/8 BSPT
M691208	5	12 mm	1/2 BSPT